

# *Owner's Guide and Installation Instructions*



## *Rheem IQ<sup>TM</sup> Tariff Intelligent Controller Version 1.1*



This Tariff Controller must be installed and serviced by a qualified person.  
Please leave this guide with the householder or premises responsible officer.

**Notice to Victorian Customers from the Victorian Building Authority**

**This Tariff Controller must be installed by a licensed person as required by The Victorian Building Act 1993**

Only a licensed person will give you a Compliance Certificate, showing that the work complies with all the relevant standards. Only a licensed person will have insurance protecting their workmanship for 6 years. Make sure you use a licensed person to install this Tariff Controller and ask for your Compliance Certificate.

**⚠ Warning:** Upon completion of the installation and commissioning of the Tariff Controller, leave this guide with the householder or responsible officer. **DO NOT** leave this guide inside of the cover of the heat pump, as it may interfere with the safe operation of the heat pump or ignite when the heat pump is turned on.

**Installation Information**

**Date of  
installation:**

---

**Installed by:**

---

**Purchased  
from:**

---

21 Atkinson Street Liverpool NSW 2170  
PO Box 146, Moorebank NSW 1875  
ABN: 28 062 383 224  
ACN: 062 383 224

Rheem Pool Heating Advisory: 1300 132 950  
National Service Line: 1300 549 883  
Email: [sales@accentair.com.au](mailto:sales@accentair.com.au)  
[www.rheempoolheating.com.au](http://www.rheempoolheating.com.au)

**PATENTS**

This Tariff Controller may be protected by one or more patents or registered designs.

® Registered trademark of Rheem Australia Pty Ltd.  
™ Trademark of Rheem Australia Pty Ltd.

---

## CONTENTS

---

### PREMISES HOUSEHOLDER OR RESPONSIBLE OFFICER

The 'About Your Tariff Controller' section is intended for the premises householder or responsible officer

The 'Installation' section is intended for the installer but may be of interest

<b>ABOUT YOUR TARIFF CONTROLLER</b> .....	4
HOW YOUR TARIFF CONTROLLER WORKS .....	6
How to set up your controller .....	6
SAVE A SERVICE CALL .....	7
CONTROLLER OPERATION .....	8
Controller Overview .....	8
Operation Overview .....	8
Setting The Current Date & Time .....	9
To Turn The Heat Pump ON by the keypad .....	9
To Turn The Heat Pump OFF by the keypad .....	9
Programming for Tariff Control .....	10
Programming for Scheduler Control .....	11
Enabling or Disabling Scheduler and/or Tariffs .....	12
Adjusting the Setpoint Temperature .....	12
Setting the Circulating Pump Control Method .....	13
Alarm Indication .....	14
Scheduler Special Event (For When Going on Holidays).....	14
TROUBLESHOOTING .....	16
<b>INSTALLATION</b> .....	17
Controller Installation Procedure .....	18
Controller Setup Procedure .....	18
ADVANCED SETUP & ADVANCED FUNCTIONS.....	19
Initial System Setup .....	19
Parameter Settings by Model Table .....	21
Programming Using SmartKey (Hotkey) .....	22
Enable Unit ON / OFF by Flow Switch .....	22
Viewing Inputs & Outputs on the Control Panel .....	22
BMS Information .....	24
Board Switch Menu.....	27
Service Menu .....	27
ALARM INDICATION & TROUBLESHOOTING .....	28
WIRING DIAGRAM.....	29

---

## ABOUT YOUR TARIFF CONTROLLER

---

### INTRODUCTION & PRODUCT APPLICATION

This tariff controller is provided as part of a heat pump or chiller system and this document pertains to the installation, operation and programming of the wall or panel mount controller only. Refer to the Owners Guide and Installation Instructions supplied with the heat pump or chiller unit for information regarding system installation and product application. Note: The term 'heat pump' is used throughout this document and also refers to 'chiller unit' for installations using a chiller system.

### MODEL TYPE

Congratulations for choosing a Rheem® Tariff Controller. There are two types of controllers available which are as follows:

- Rheem Panel Mount Tariff Controller that is suitable for either indoor or outdoor installation.
- Rheem Wall Mount Tariff Controller that is suitable for indoor installation only.

### HOW DO I KNOW IF THE CONTROLLER IS INSTALLED CORRECTLY?

Installation requirements are detailed in the 'Installation' section starting on page 17. The controller must be installed:

- by a qualified person, and
- in accordance with these installation instructions, the installation instructions supplied with the heat pump and
- in compliance with Standards AS/NZS 3000, AS/NZS 3500.4, as applicable under local regulations, and all local codes and regulatory authority requirements.
- In New Zealand, the installation must also conform with the New Zealand Building Code.

### PRECAUTIONS

If this controller is to be used where uninterrupted heating or cooling is necessary for your application or business, you should ensure that you have back up redundancy within the heating or cooling system design. This should ensure the continuity of heating or cooling in the event that this controller was to become inoperable for any reason. We recommend you seek advice from your installer or specifier about your needs and building back up redundancy into your heating or cooling system.

### POWER OUTAGES

If the power supply to the heat pump is interrupted for any reason, the heat pump and controller will shut down and cease to operate.

When power is restored, the heat pump will automatically operate in the last used mode of operation and any settings programmed on the controller will remain unaffected i.e. will be the same values as before the power outage.

### CLEANING THE CONTROLLER

If the controller requires cleaning, wipe with a soft dry cloth. If controller buttons require cleaning, ensure the heat pump is turned off at the electrical isolator located adjacent to the heat pump to prevent the inadvertent alteration of controller settings. **Note:** Do not use a cleaning cloth with thinners, benzene, acid or alkaline detergents as these products will discolour the display and plastic components which is not covered by warranty.

### WARRANTY

The controller is supported by a manufacturer's warranty providing one year on parts. For more information refer to the Installation Instructions supplied with the heat pump or contact Accent Air Service department on 1300 549 883. Information is also available on the Rheem Pool Heating website [www.rheempoolheating.com.au](http://www.rheempoolheating.com.au)

### GENERAL WARNINGS & SAFETY ADVICE

**⚠ Warning:** For your safety do not operate this controller before reading this instruction booklet.

**⚠ Warning:** This controller is only intended to be operated by persons who have the experience or the knowledge and the capabilities to do so. This controller is not intended to be operated by persons (including children) with reduced physical, sensory or mental capabilities, or lack of experience and knowledge.

**⚠ Warning:** Children should be supervised to ensure they do not interfere or play with the controller.

**⚠ Warning:** For continued safety of this controller it must be installed, operated and maintained in accordance with the Owner's Guide and Installation Instructions.

Improper installation, adjustment, alteration, service or maintenance can cause injury or property damage. For assistance or additional information consult your Rheem Distributor, qualified Installer, or accredited Service Agent.

**The warranty can become void if the installation is not in accordance with these instructions.**

- DO NOT use the controller if any part is faulty or damaged. Immediately call Accent Air Service department or an accredited Service Agent to arrange for an inspection.
- DO NOT use the controller if any part has been under water. Immediately call Accent Air Service department or an accredited Service Agent to arrange for an inspection.

---

## HOW YOUR TARIFF CONTROLLER WORKS

---

Congratulations on your choice of a Rheem Heat Pump Tariff Controller. Rheem is committed to environmental sustainability and continually strives to be innovative in product development to help Australian households reduce their energy usage. Your Rheem heat pump and tariff controller are a strong reflection of this commitment.

The heat pump that you have purchased is designed to be energy efficient and the tariff functionality of the controller enables you to optimise heat pump and recirculating pump operation relative to the price of electricity.

The main energy source for your heat pump is naturally available heat; either from surrounding air, water or from the earth itself. These heat sources are totally renewable and provide up to four fifths of the energy that the heat pump requires to operate. The remaining energy required is supplied by electricity and it is this energy usage that the tariff controller focuses on to enable you to achieve lower heating costs.

The structure and pricing of electricity varies from state to state and supplier to supplier. The simplest pricing structure is a flat rate, however digital metering now allows for off-peak, shoulder and peak-time electricity use tariffs. The pricing structure may also vary according to the time of day or if it is a work day, weekend or public holiday and even in some instances according to the season.

Where electricity has a time of use basis, the opportunity is created to achieve substantial savings in heating costs because the price of electricity in off-peak hours can be less than one quarter of the day peak-time rate!

Control options can be as simple as restricting heat pump operation to off-peak times only or to off-peak and shoulder periods only. The more sophisticated option is to set varying target water temperatures and differentials by time of day and day of the week. This sounds complicated but is easily achieved by following the step by step procedures outlined in the 'Controller Operation' section of these instructions.

The development of this controller included detailed evaluation of all Australian electricity tariffs and some common tariff options are preloaded into the controller. In these instances all that is required is to nominate the target water temperature settings (setpoint) and differentials for these periods. Programming of every possible tariff option is also readily performed, allowing you to fully customise heat pump and recirculating pump operation both in terms of temperature needs and tariff pricing. This allows you to minimise your running costs while retaining the benefits of your heating or cooling system.

### HOW TO SET UP YOUR CONTROLLER

1. Read 'Controller Overview' and 'Operation Overview' sections on page 8.
2. Set current date and time (refer to 'Setting the Current Date & Time on page 9).
3. Set and enable tariffs (refer to 'Programming for Tariff Control' on page 10).
4. Set and enable scheduler times if this option is required (refer to 'Programming For Scheduler Control' on page 11).
5. Adjust the setpoint temperature (refer to 'Adjusting the Setpoint Temperature' on page 12).
6. Set the circulating pump control method (Refer to 'Setting the Circulating Pump Control Method' on page 13).
7. Turn heat pump ON (refer to 'To Turn the Heat Pump ON by the Keypad' on page 9).

Your heat pump tariff controller has now been configured and will automatically operate according to the settings you have programmed.

---

## SAVE A SERVICE CALL

---

**Check the items below before making a service call. Charges apply for attending to any condition or fault that is not related to manufacture or failure of a part.**

**Note:** The controller and heat pump will have a start delay when turned on. This is normal operation.

### HEAT PUMP OR CONTROLLER NOT OPERATING

- **Is the electricity switched on?**  
If the controller display is blank, ensure power is available and that the heat pump is switched on at the electrical isolator located adjacent to the heat pump.
- **Is the heat pump manually turned on at the keypad?**  
Ensure the heat pump is turned ON at the controller keypad (refer to 'To Turn the Heat Pump ON by the keypad' on page 9).
- **Is the alarm (🔔) button on the controller flashing red or is a message displayed?**  
Refer to 'Troubleshooting' on page 16 if an alarm condition occurs or if a message is displayed on the controller.
- **Is the controller programmed correctly?**  
Check to ensure any scheduled and/or tariff time periods are programmed correctly and that 'scheduler' and/or 'tariffs' are enabled. Also check to ensure the setpoint and differential settings are correct for each period and that the current date and time is correctly set (refer to 'Controller Operation' section on page 8).

### HEATER NOT SUFFICIENTLY HEATING

- **Is the setpoint temperature too low?**  
Increase the setpoint temperature (refer to 'Adjusting the Setpoint Temperature' on page 12).
- **Is the controller programmed correctly?**  
Refer to the same question in the 'Heat Pump or Controller Not Operating' section above.
- **Is there excessive heat loss?**  
Swimming pools and spas can benefit from a cover to retain heat when not in use.
- **Is the heat pump correctly sized?**  
The sizing guide in the Rheem sales literature and on the Rheem website ([www.rheempoolheating.com.au](http://www.rheempoolheating.com.au)) suggests average sizes that may be needed.

### WATER GETS TOO HOT

- **Is the setpoint temperature too high?**  
Decrease the setpoint temperature (refer to 'Adjusting the Setpoint Temperature' on page 12).

### HIGH ELECTRICITY BILLS

Should you at any time feel your electricity account is too high, we suggest you check the following points:

- Consider recent changes in weather or to your heating pattern (such as an increase in heating periods or temperature settings) and check if there has been any increase in tariffs since your previous account.
- Is there excessive heat loss? Swimming pools and spas can benefit from a cover to retain heat when not in use.

**IF YOU HAVE CHECKED ALL THE ABOVE AND STILL BELIEVE YOU NEED ASSISTANCE, PHONE ACCENT AIR SERVICE DEPARTMENT ON 1300 549 883 OR CONTACT YOUR INSTALLER.**

---

## CONTROLLER OPERATION

---

### CONTROLLER OVERVIEW

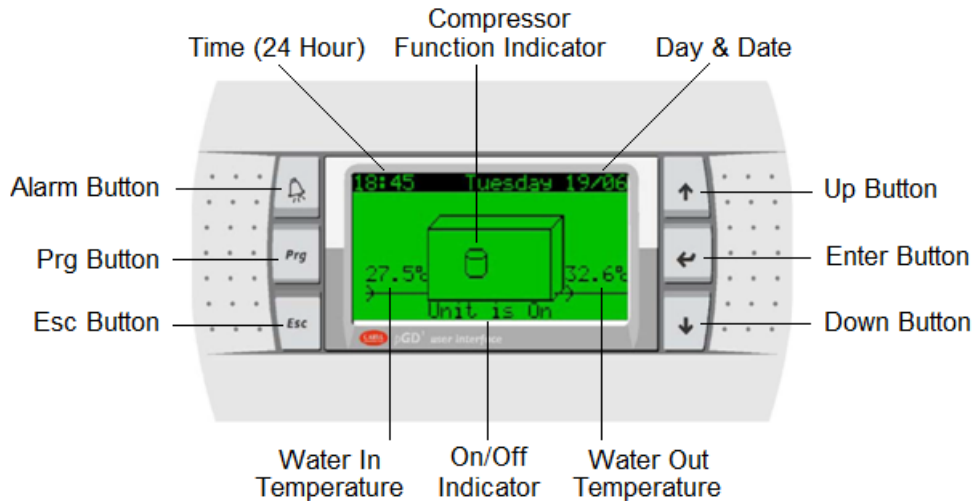

The home screen is the default screen that the controller will display when first powered up and is depicted in the illustration above. The controller will also revert to the home screen if the keypad buttons have been inactive for a period of 60 seconds.

### OPERATION OVERVIEW

There are three methods of heat pump control; scheduler, tariffs and keypad control.

- If only 'scheduler' is enabled, the heat pump will operate according to the programmed scheduler ON and OFF time periods to maintain the target setpoint temperature. Note: When in a scheduler OFF period, the control panel will display 'Unit OFF by SCHEDULE'.
- If only 'tariffs' are enabled, the heat pump will continuously operate according to the programmed tariff settings to maintain the target setpoint temperature.
- If 'scheduler' and 'tariff' are both enabled, the heat pump will operate according to the programmed scheduler ON and OFF time periods to maintain the target setpoint temperature according to the programmed tariff settings.
- If 'scheduler' and 'tariff' are both disabled, the heat pump will not operate unless the heat pump is manually turned ON by the keypad at which time the heat pump will continuously operate to maintain the target setpoint temperature.
- The heat pump must be manually turned ON by the keypad for the heat pump to operate according to the scheduler or tariffs.
- The heat pump can be manually turned OFF by the keypad regardless of programmed scheduler or tariff settings. Note: When manually turned OFF by the keypad, the control panel will display 'Unit OFF by KEYPAD'.

Note: Scheduler time periods and/or tariff periods must be correctly programmed and enabled, the current date and time must be correctly set and the heat pump must be manually turned on by the keypad for the heat pump to be able to operate according to scheduler time periods and/or tariffs.

### Going on Holidays?

Your tariff controller can be used to lower the water temperature of your pool or spa while you are away to save running costs. Refer to 'Scheduler Special Event' on page 14.



### SETTING THE CURRENT DATE & TIME

The current date and time must be set correctly for the heat pump to be able to operate according to scheduled time periods and/or tariff periods. The time is displayed in 24 hour time.

1. Whilst in the home screen, press and release **Esc**. The screen will change to the 'Main menu'.
2. Press and release **↑** or **↓** until **'C. Clock/Scheduler'** is selected.
3. Press and release **←**. The **'Clock 01'** screen will be displayed as shown below.



4. Press and release **←** to move the cursor to the value to be changed.
5. Press and release **↑** or **↓** until the desired setting is displayed.
6. Repeat steps 4 and 5 until all required changes have been made then proceed to step 7.
7. Press and release **←** to confirm the selection. The screen will change back to the home screen and the setting will be saved.

### TO TURN THE HEAT PUMP ON BY THE KEYPAD

Perform the following procedure to turn the heat pump ON.

1. Whilst in the home screen, press and release **Esc**. The screen will change to the 'Main menu'.
2. Press and release **↑** or **↓** until **'A. On/Off Unit'** is selected.
3. Press and release **←**. The screen will change to show 'OFF'.
4. Press and release **←**. The 'O' in 'OFF' will start flashing.
5. Press and release **↑** or **↓**. The screen will change to show 'ON' with the 'O' flashing.
6. Press and release **←** to confirm the selection. The 'O' in 'ON' will stop flashing and the heat pump will be turned ON.
7. Press and release **Esc** twice to go back to the home screen.

### TO TURN THE HEAT PUMP OFF BY THE KEYPAD

Perform the following procedure to turn the heat pump OFF.

1. Whilst in the home screen, press and release **Esc**. The screen will change to the 'Main menu'.
2. Press and release **↑** or **↓** until **'A. On/Off Unit'** is selected.
3. Press and release **←**. The screen will change to show 'ON'.
4. Press and release **←**. The 'O' in 'ON' will start flashing.
5. Press and release **↑** or **↓**. The screen will change to show 'OFF' with the 'O' flashing.
6. Press and release **←** to confirm the selection. The 'O' in 'OFF' will stop flashing and the heat pump will be turned OFF.
7. Press and release **Esc** twice to go back to the home screen.

## PROGRAMMING FOR TARIFF CONTROL

When the controller has been programmed and enabled for tariff control, the heat pump will operate according to the programmed tariffs provided the heat pump is manually turned ON by the keypad.

There are two methods of programming for tariff control. 'Programming Default Tariff Settings' or 'Programming Tariff Settings Manually'.

Note: The current date and time must be set correctly for the heat pump to be able to operate according to programmed tariffs and if the scheduler is enabled, the scheduler must be in a current ON period.

### Programming Default Tariff Settings

Programming default tariff settings loads and enables the default tariff settings preloaded into the controller.

1. Whilst in the home screen, press and release **Esc**. The screen will change to the 'Main menu'.
2. Press and release **↑** or **↓** until **C. Clock/Scheduler** is selected.
3. Press and release **←**. The **Clock 01** screen will be displayed. If 'enable tariff' is already set to 'Yes' proceed directly to step 7. If 'enable tariff' is set to 'No' proceed to step 4.
4. Press and release **←** until the curser selects 'enable tariff: No'.
5. Press and release **↑** or **↓** to change to 'Yes'.
6. Press and release **←** until the curser disappears.
7. Press and release **↑** or **↓** until the screen changes to the **Tariff Timeband 05** screen shown below.



8. Press and release **←** until the curser selects the desired state. Note: 'Custom' is for future expansion and although default settings are loaded they are not currently valid.
9. Press and release **↑** or **↓** to change to 'Yes'.
10. Press and release **←** to confirm the selection. **\*\*DEFAULT LOADED\*\*** should appear on the bottom of the screen when the default tariff settings have been loaded.
11. Press and release **Esc** twice to go back to the home screen.

### Programming Tariff Settings Manually

Programming tariff settings manually enables you to tailor tariff settings according to your local area or energy supplier if the tariff time periods differ to the default tariff settings.

1. Whilst in the home screen, press and release **Esc**. The screen will change to the 'Main menu'.
2. Press and release **↑** or **↓** until **C. Clock/Scheduler** is selected.

## CONTROLLER OPERATION

---

3. Press and release **←**. The **Clock 01** screen will be displayed. If 'enable tariff' is already set to 'Yes' proceed directly to step 7. If 'enable tariff' is set to 'No' proceed to step 4.
4. Press and release **←** until the cursor selects 'enable tariff: No'.
5. Press and release **↑** or **↓** to change to 'Yes'.
6. Press and release **←** until the cursor disappears.
7. Press and release **↑** or **↓** until the screen changes to the 'Tariff Timeband' screen that you would like to change a period for. There are four of these screens (PM Week-end, AM Week-end, PM Weekday and AM Weekday).



8. Press and release **←** until the cursor selects the desired hour period to be changed (each letter on the clock represent one hour).
9. Press and release **↑** or **↓** to change the selected hour to the desired tariff type (Shoulder, Off-peak or Peak).
10. Press and release **←** to confirm the selection.
11. Perform steps 8 ~ 10 until all time periods have been changed to the desired tariff types.
12. Perform steps 7 ~ 11 for all four Tariff Timeband' screens.
13. Press and release **Esc** twice to go back to the home screen.

For example: In the screen illustration shown above, the three 'P' hours represent a peak period from 6:00am to 9:00am for all weekdays.

### PROGRAMMING FOR SCHEDULER CONTROL

When the controller has been programmed and enabled for scheduler control, the heat pump will operate according to the programmed scheduler ON and OFF time periods provided the heat pump is manually turned ON by the keypad.

Note: The current date and time must be set correctly for the heat pump to be able to operate according to scheduler time periods.

1. Whilst in the home screen, press and release **Esc**. The screen will change to the 'Main menu'.
2. Press and release **↑** or **↓** until **C. Clock/Scheduler** is selected.
3. Press and release **←**. The **Clock 01** screen will be displayed. If 'enable scheduler' is already set to 'Yes' proceed directly to step 7. If 'enable scheduler' is set to 'No' proceed to step 4.
4. Press and release **←** until the cursor selects 'enable scheduler: No'.
5. Press and release **↑** or **↓** to change to 'Yes'.
6. Press and release **←** until the cursor disappears.

7. Press and release **↑** or **↓** until the screen changes to the 'Clock Schedule' screen as depicted in the following illustration.



8. Press and release **←** until the cursor selects the desired day/time ON period to be set.  
 9. Press and release **↑** or **↓** to change the selected day/time/ period to the ON time required.  
 10. Press and release **←** until the cursor selects the desired day/time OFF period to be set.  
 11. Continue performing steps 8 ~ 10 for all day ON and OFF time periods required.  
 12. Press and release **Esc** twice to go back to the home screen.

For example: MON 07:00 to 17:30 would represent an ON time of 7:00 am and an OFF time of 5:30 pm on Mondays.

### ENABLING OR DISABLING SCHEDULER AND/OR TARIFFS

Refer to 'Operation Overview' on page 8 for various scheduler and tariff control methods to determine enabling/disabling requirements. Disabling the scheduler and/or tariffs will not clear any programmed scheduler time periods or tariffs, only disable their operation until they are enabled again.

Note: Scheduler time periods and/or tariff periods must be correctly programmed and enabled, the current date and time must be correctly set and the heat pump must be manually turned on by the keypad for the heat pump to be able to operate according to scheduler time periods and/or tariffs.

Scheduler time periods and/or tariffs periods can be enabled or disabled as follows:

1. Whilst in the home screen, press and release **Esc**. The screen will change to the 'Main menu'.
2. Press and release **↑** or **↓** until **C. Clock/Scheduler** is selected.
3. Press and release **←**. The **Clock 01** screen will be displayed.
4. Press and release **←** until the cursor selects 'enable scheduler' or 'enable tariff'.
5. Press and release **↑** or **↓** until the desired setting (Yes or No) is displayed.
6. Press and release the **←** button to confirm the selection.
7. Press and release **Esc** twice to go back to the home screen.

### ADJUSTING THE SETPOINT TEMPERATURE

The 'Setpoint temperature' is the target temperature for the heat pump to operate to.

There are two methods for adjusting the setpoint temperature depending whether tariffs are enabled or disabled (for information on enabling or disabling tariffs refer to 'Enabling or Disabling Scheduler and/or Tariffs' on page 12). The setpoint can be adjusted with tariffs enabled or disabled as follows:

### Adjusting the Setpoint Temperature With Tariffs Disabled

1. Whilst in the home screen, press and release **Prg**. The screen will change to show **Setpoint 01** and the setpoint value will start flashing.
2. Press and release **↑** or **↓** until the desired setpoint temperature is displayed.
3. Press and release **↵** to confirm the selection. The screen will change back to the home screen and the setting will be saved.

### Adjusting the Setpoint Temperature With Tariffs Enabled

When tariffs are enabled there are two types of settings that need to be set; the setpoint temperature and the proportional band (differential).

The 'Setpoint temperature' is the target temperature for the heat pump to operate to. The proportional band is the change in temperature away from the set point before the heat pump will come on.

For example: If the heat pump has a set point of 30°C and a proportional band of 0.5°C, the heat pump will come on if the water temperature falls below 29.5°C and turn off when the water temperature reaches 30°C.

It is recommended to keep the same setpoint for each tariff time period and the proportional bands at 0.5°C for off-peak periods, 1.0°C for shoulder periods and 2.0°C for peak periods. The larger proportional band for peak periods will delay the onset of the heat pump which will save power consumption during these more expensive operating periods.

1. Whilst in the home screen, press and release **Prg**. The screen will change to show **Setpoint – Tariff 0X** (where X is the tariff period number).
2. Press and release **↑** or **↓** to navigate to the desired tariff period.
3. Press and release **↵** to confirm the selection. The setpoint value will start flashing.
4. Press and release **↑** or **↓** until the desired setpoint temperature is displayed.
5. Press and release **↵** to confirm the selection. The proportional band value will start flashing.
6. Press and release **↑** or **↓** until the desired proportional band value is displayed.
7. Press and release **↵** to confirm the selection. The proportional band value will stop flashing and the settings will be saved.
8. Perform steps 2 ~ 7 for all other available tariff periods then proceed to step 9.
9. Press and release **Esc** once to go back to the home screen.











### SETTING THE CIRCULATING PUMP CONTROL METHOD

The circulating pump control method setting is utilised to control operation of the system water pump(s) and should be set at time of installation by the Installer. This setting does not normally require changing.

If set on 'PERMANENT', the water pump(s) will always be ON or controlled externally of the heat pump.



If set on 'CYCLE TO TEST TEMP', the water pump(s) will automatically turn OFF after the heat pump has reached the set temperature. When on this setting the water pump(s) will also be automatically turned ON after the temperature test cycle time setting so that the heat pump can check the current water temperature. This setting is the most economical if the water pump(s) are to be controlled by the heat pump.

1. Whilst in the home screen, press and release **Esc**. The screen will change to the 'Main menu'.
2. Press and release **↑** or **↓** until **A. On/Off Unit** is selected.

3. Press and release . The screen will change to show 'ON' or 'OFF'.
4. Press and release  or . The screen will change to show 'Type of circulating pump control' and the current setting.
5. Press and release . The first letter in the current setting will start flashing.
6. Press and release  or  until the desired setting is displayed.
7. Press and release  to confirm the selection. If 'PERMANENT' was selected, the setting has now been saved and you must proceed directly to step 10. If 'CYCLE TO TEST TEMP' was selected, proceed to step 8.
8. The first digit in the 'temp test cycle' time will now be flashing. Press and release  or  until the desired time setting is displayed. The time setting can be changed in 0.5 hour increment from 0.0 to 5.0 hours.
9. Press and release  to confirm the time selection. The first digit in the 'temp test cycle' time will stop flashing and the setting will be saved.
10. Press and release **Esc** twice to go back to the home screen.







## ALARM INDICATION

If the system detects an alarm condition, the alarm button () will illuminate and flash red.

1. Press and release  to display the active alarm condition. The controller will display the active alarm fault message (refer to 'Troubleshooting' on page 16 for a detailed list of all available alarm messages and their meanings).
2. Press and hold  for 2 seconds to clear the active alarm. If the alarm condition has cleared, the alarm button will extinguish and the heater will resume normal operation. Note: If the alarm condition is still present the alarm will immediately reactivate.
3. Press and release **Esc** once to go back to the home screen.

## Viewing Alarm History

All alarm conditions are logged in the controller's data logger which can log up to 150 alarm conditions including information such as alarm type, date and time and various system temperatures taken at the time the alarm condition occurred. Each alarm condition is numbered in the top left hand corner in chronological order. i.e. #01, #02 e.t.c. where #02 was the last occurring alarm condition. To view the alarm history, perform the following procedure:

1. Whilst in the home screen, press and release **Esc**. The screen will change to the 'Main menu'.
2. Press and release  or  until **E. Alarm History** is selected.
3. Press and release . The screen will change to show the last occurring (or last viewed) alarm condition along with relevant alarm information. Each condition is numbered in the top left hand corner in chronological order. i.e. #01, #02 e.t.c. where #02 was the last occurring alarm condition.
4. Press and release  or  to navigate through the alarm history one alarm condition at a time. Pressing and holding  or  will quickly navigate through the history.
5. Press and release **Esc** twice to go back to the home screen.

## SCHEDULER SPECIAL EVENT (FOR WHEN GOING ON HOLIDAYS)

If the premises will be vacant for a period of time, the controller can be programmed to reduce the setpoint temperature and proportional band (differential) during the vacant period to save on running costs. This method is preferable to turning the heat pump OFF because reheating a pool

## CONTROLLER OPERATION

---

or spa from a cold start requires more energy. Note: For vacant periods of 4 weeks or more it is more economical to turn the heat pump off while you are away.

As a guide, Rheem recommends reducing the setpoint temperature to 20°C and the proportional band (differential) to 3°C from when the premises will be vacant until 3 days before the premises will be occupied again. This will allow 3 days for the system to return to the normal setpoint temperature (this period could be reduced to 1 day for small spas).

1. Whilst in the home screen, press and release **Esc** . The screen will change to the 'Main menu' screen.
2. Press and release **↑** or **↓** until **C. Clock/Scheduler** is selected.
3. Press and release **←**. The **Clock 01** screen will be displayed.
4. Press and release **↑** or **↓** until the **Clock Schedule 03** screen is displayed.
5. Press and release **←**. The cursor will be on 'Special Event' 'Yes' or 'No'.
6. Press and release **↑** or **↓** to select 'Yes'.
7. Press and release **←** to confirm the selection.
8. Continue using **←** to navigate through the remaining settings and continue using **↑** or **↓** to change the remaining settings to the required values.
9. When the differential has been set, Press and release **←**. The cursor will disappear and the settings will be saved.
10. Press and release **Esc** twice to go back to the home screen.

## TROUBLESHOOTING

If the system detects an alarm condition, the alarm button (  ) will illuminate and flash red. A message may also be displayed on the controller indicating an error condition.

Problem	Possible Cause	Checks	Action
Heat pump not running	Heat Pump is turned OFF	Home screen reads 'Unit OFF by KEYPAD'	Turn heat pump on (page 9)
	Heat Pump is OFF by scheduler	Home screen reads 'Unit OFF by SCHEDULE'	Check to ensure time is correctly set (page 9)
			Check to ensure scheduler is correctly set (page 11)
			Disable scheduler if not required (page 12)
	Heat Pump is OFF by digital input	Home screen reads 'Unit OFF by REMOTE in'	Turn remote input ON or contact installer
	Heat Pump is OFF by supervisor	Home screen reads 'Unit OFF by SUPERVISOR'	BMS OPERATION or contact installer
Heat Pump has reached setpoint	Check temperature on control panel display	No action required.	
Alarm – Flow Switch	Pump not operating	Check to ensure pump is operating	Turn pump ON and clear alarm (page 14)
	Blockage in water system	Check for obstructions at inlets, outlets, filters etc	Clear obstructions and clear alarm (page 14)
Alarm – High Pressure Safety	Blockage in water system	Check for obstructions at inlets, outlets, filters etc	Clear obstructions and clear alarm (page 14)
	Fouled heat exchanger		Contact installer
	Dirty coil (chiller units only)	Outdoor unit is dirty or dust has built up around coil	Turn OFF power and hose down outside unit through louvres. Restore power and clear alarm (page 14)
	Faulty fan(s)	Check to ensure both fans are spinning in the same direction and speed	Contact installer
	Ambient temperature too high (chiller units only)	Wait for outside temperature to drop	Clear alarm (page 14)
	Incorrect refrigerant charge		Contact installer
Alarm – Low Pressure Safety	Incorrect de-ice function or refrigerant gas leak	Ice build up on unit	Contact installer
	Probe faulty or probe wiring is open or short circuit	No temperature reading on control panel display	Contact installer
Alarm – Probe fault	Probe faulty	No temperature reading on control panel display	Contact installer

**IF YOU HAVE CHECKED ALL THE FOREGOING AND STILL BELIEVE YOU NEED ASSISTANCE, PHONE ACCENT AIR SERVICE DEPARTMENT ON 1300 549 883 OR CONTACT YOUR INSTALLER.**



---

# INSTALLATION

---

## INTRODUCTION & PRODUCT APPLICATION

This tariff controller is provided as part of a heat pump or chiller system and this document pertains to the installation, operation and programming of the wall or panel mount controller only. Refer to the Owners Guide and Installation Instructions supplied with the heat pump or chiller unit for information regarding system installation and product application. Note: The term 'heat pump' is used throughout this document and also refers to 'chiller unit' for installations using a chiller system.

## PRECAUTIONS

If this controller is to be used where uninterrupted heating or cooling is necessary for your application or business, you should ensure that you have back up redundancy within the heating or cooling system design. This should ensure the continuity of heating or cooling in the event that this controller was to become inoperable for any reason. We recommend you seek advice from your installer or specifier about your needs and building back up redundancy into your heating or cooling system.

## INSTALLATION STANDARDS

The controller must be installed:

- by a qualified person, and
- in accordance with these installation instructions, the installation instructions supplied with the heat pump and
- in compliance with Standards AS/NZS 3000, AS/NZS 3500.4, as applicable under local regulations, and all local codes and regulatory authority requirements.
- In New Zealand, the installation must also conform with the New Zealand Building Code.

## MODEL TYPE

These are two types of controllers available which are as follows:

- Rheem Panel Mount Controller that is suitable for either indoor or outdoor installation.
- Rheem Wall Mount Controller that is suitable for indoor installation only.

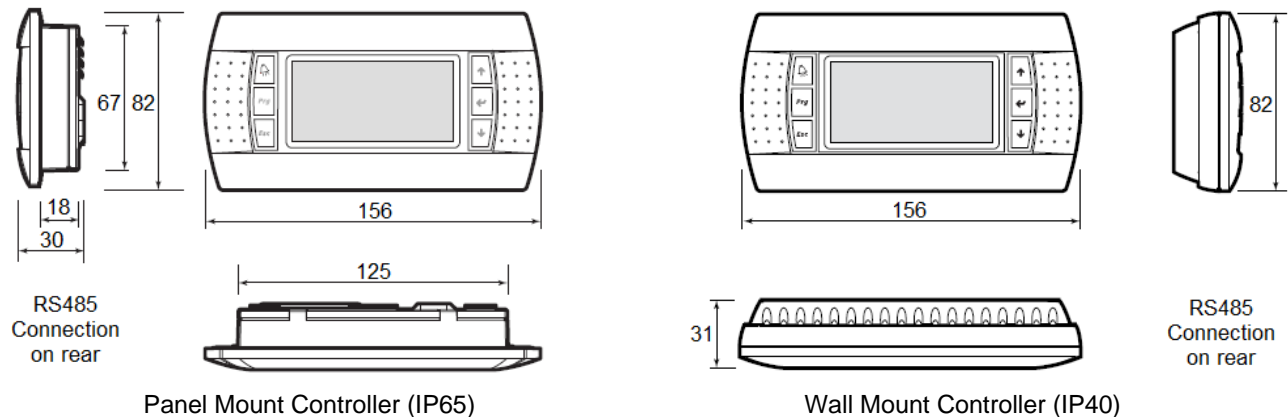

## FASCIA REMOVAL

1. Using a small flat bladed screwdriver, locate screwdriver blade in small recess under bottom edge of fascia and flick fascia away from controller.
2. To reassemble, locate fascia over controller so that bottom edge is in position, then push top edge of fascia until fascia clicks into position.

### CONTROLLER INSTALLATION PROCEDURE

Note: When installing a panel mount controller in an outdoor position, ensure the controller IP rating is maintained (IP65) i.e. the enclosure in which the controller is mounted must have a suitable IP rating. Water damage to the controller is not covered by warranty if the IP rating of the installation is not maintained.

1. Determine controller location taking into consideration the maximum cable length of 10 metres using telephone cabling. Note: For cable lengths greater than 10 metres and up to 200 metres AWG24 shielded cable can be used.
2. For panel mount controller, mark and perform cut out according to the template shown below. For wall mounted controllers, skip this step.

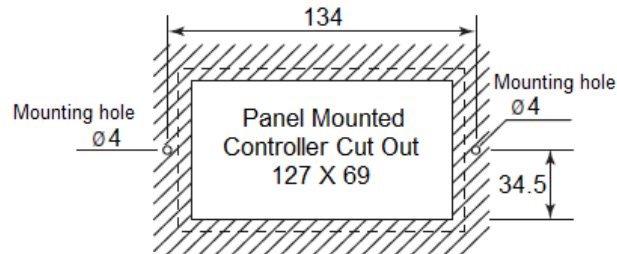

3. Connect cable to rear of controller.
4. Mount controller using screws provided or suitable fixing hardware.

### CONTROLLER SETUP PROCEDURE

Perform the following procedure to program controller settings according the type of installation and customer requirements (refer to 'Controller Overview' on page 8 for a depiction of the controller and home screen if required):

1. Perform initial system setup if required (refer to 'Initial System Setup' on page 19). **Note: The initial setup is normally performed by the manufacturer and this step is only required to be performed for advanced systems that require customisation.** Skip this step for all standard models.
2. Set current date and time (refer to 'Setting the Current Date & Time on page 9).
3. Set and enable tariffs (refer to 'Programming for Tariff Control' on page 10).
4. Set and enable scheduler times if this option is required (refer to 'Programming For Scheduler Control' on page 11).
5. Adjust the setpoint temperature (refer to 'Adjusting the Setpoint Temperature' on page 12).
6. Set the circulating pump control method (refer to 'Setting the Circulating Pump Control Method' on page 13).
7. Set the flow switch control method (refer to 'Enable Unit ON / OFF by Flow Switch' on page 14).
8. Turn heat pump ON (refer to 'To Turn the Heat Pump ON by the Keypad' on page 9) and commission heat pump or chiller unit (refer to the installation instructions supplied with the heat pump or chiller unit for commissioning procedure).
9. Explain control panel operation to the customer.
10. Leave these instructions with the householder or responsible officer.

---

## ADVANCED SETUP & ADVANCED FUNCTIONS

---

### INITIAL SYSTEM SETUP

**Note: The initial setup is normally performed by the manufacturer and this step is only required to be performed for advanced systems that require customisation.**

While performing the following procedures, use the **↑** or **↓** buttons to set values.

A four digit password is required access configurations. Contact Accent Air for the password.

#### Step 1 – Set Address:

1. Power up the unit. The controller will display the home screen.
2. Simultaneously press and hold **↑**, **↓** and **←** for 5 seconds to enter the setup menu
3. Press and release **←** to move cursor to 'Display address setting' and set to '32'.
4. Press and release **←** to move cursor to 'I/O board address' and set to '01'.
5. Press and release **←** to navigate to the terminal config screen.
6. Press and release **←** to move cursor to 'trm1' and set to '32'.
7. Press and release **←** to move cursor to the next position and set to 'sh'.
8. Press and release **←** to move cursor to 'trm2' and set to 'None'.
9. Press and release **←** to move cursor to the next position and set to '--'.
10. Press and release **←** to move cursor to 'trm3' and set to 'None'.
11. Press and release **←** to move cursor to the next position and set to '--'.
12. Press and release **←** to move cursor to the next position and set to 'Yes'.
13. Press and release **←** to confirm settings. The screen will change to the home screen and step 1 settings will be saved.



#### Step 2 – Set Configuration 01 Screen Parameter Settings:

Refer to 'Parameter Settings by Model Table' on page 21 for appropriate parameter values.

1. Whilst in the home screen, press and release **Esc**. The screen will change to the 'Main menu' screen.
2. Press and release **↑** or **↓** until **H. Manufacturer** is selected.
3. Press and release **←** and enter the four digit password (Set first digit then press **←** to move to the next digit etc). When the last digit has been set press and release **←**.
4. Press and release **↑** or **↓** until **a. Configuration** is selected.
5. Press and release **←** to navigate to 'Configuration 01' screen.
6. Press and release **←** to move cursor to 'Model' and set to appropriate model as follows:















Model	Description
A2WHH	Air to Water Heat Pump with Hot Gas De-Ice
A2WHR	Air to Water Heat Pump with Reverse Cycle De-Ice
A2WHC	Air to Water Heat and Cool
A2WC	Air to Water Chiller
REMOTE	Other controls such as AC1 or Saginomiya De-Ice will control unit main functions
W2WH	Water to Water Heat Pump
W2WHC	Water to Water Heat and Cool
W2WC	Water to Water Chiller

7. Press and release **←** to move cursor to 'No.Compressors' and set to the appropriate number of compressors.

8. Press and release  to move cursor to 'Reverse cycle' and set to the appropriate value.
9. Press and release  to move cursor to 'Defrost type' and set to the appropriate value.
10. Press and release . The cursor will disappear.
11. Press and release **Esc** three times to go back to the home menu. The screen will change to the home screen and step 2 settings will be saved.













### Step 3 – Set Configuration 03, 04, 05, 06 & EVO Screen Parameter Settings

Refer to 'Parameter Settings by Model Table' on page 21 for appropriate parameter values.

1. Whilst in the home screen, press and release **Esc**. The screen will change to the 'Main menu' screen.
2. Press and release  or  until **'H. Manufacturer'** is selected.
3. Press and release  and enter the four digit password (Set first digit then press  to move to the next digit etc). When the last digit has been set press and release . Note: This step will not occur if the password has been previously entered within 10 minutes.
4. Press and release  or  to until **'a. Configuration'** is selected.
5. Press and release  to navigate to 'Configuration 01' screen.
6. Press and release  to navigate to 'Configuration 03' screen.
7. Use  to move cursor and use  or  to set values for all 'Configuration 03' screen parameter settings.
8. Press and release  until the cursor disappears.
9. Press and release  to navigate to the next configuration screen.
10. Perform steps 7 ~ 9 to set parameter values for all configuration screens. Proceed to the next step when all configuration screen parameter values have been set.
11. Press and release **Esc** three times to go back to the home menu. The screen will change to the home screen and step 3 settings will be saved.

### Step 4 – Set I/O Config 01 ~ 11 Screen Parameter Settings

Refer to 'Parameter Settings by Model Table' on page 21 for appropriate parameter values.

1. Whilst in the home screen, press and release **Esc**. The screen will change to the 'Main menu' screen.
2. Press and release  or  until **'H. Manufacturer'** is selected.
3. Press and release  and enter the four digit password (Set first digit then press  to move to the next digit etc). When the last digit has been set press and release . Note: This step will not occur if the password has been previously entered within 10 minutes.
4. Press and release  or  until **'b. I/O Configuration'** is selected.
5. Press and release  to navigate to 'I/O Config 01' screen.
6. Use  to move cursor and use  or  to set values for all 'I/O Config 01' screen parameter settings.
7. Press and release  until the cursor disappears.
8. Press and release  to navigate to the next configuration screen.
9. Perform steps 6 ~ 8 to set parameter values for all I/O Config screens. Proceed to the next step when all I/O Config screen parameter values have been set.
10. Press and release **Esc** three times to go back to the home menu. The screen will change to the home screen and step 3 settings will be saved.

## PARAMETER SETTINGS BY MODEL TABLE

Screen	Parameter Setting	A2WHH *	A2WHR	A2WHC	A2WC	REMOTE	W2WH	W2WHC	W2WC
Configuration 01	Model	A2WHH	A2WHR	A2WHC	A2WC	REMOTE	W2WH	W2WHC	W2WC
	No. Compressors	Set as required	Set as required	Set as required	Set as required	Set as required	Set as required	Set as required	Set as required
	Reverse Cycle	No	Yes	Yes	No	No	No	Yes	No
	Defrost Type	HGB	R/C	R/C	None	None	None	None	None
Configuration 03	Type of condenser fans fitted	Set as required	Set as required	Set as required	Set as required	Screen not avail	Set as required	Set as required	Set as required
	Electronic Expansion Valve Fitted	Set as required	Set as required	Set as required	Set as required	Screen not avail	Set as required	Set as required	Set as required
	Refrigerant	Set as required	Set as required	Set as required	Set as required	Screen not avail	Set as required	Set as required	Set as required
Configuration 04	Type of circulating pump control	Cycle to test pump	Cycle to test pump	Cycle to test pump	Cycle to test pump	Cycle to test pump	Cycle to test pump	Cycle to test pump	Cycle to test pump
	Flow Switch Fitted	Set as required	Set as required	Set as required	Set as required	Set as required	Set as required	Set as required	Set as required
	User Type	Set as required	Set as required	Set as required	Set as required	Set as required	Set as required	Set as required	Set as required
Configuration 05	L.P. safety device type	Digital Input	Digital Input	Digital Input	Digital Input	Screen not avail	Digital Input	Digital Input	Digital Input
Configuration 06	H.P. safety device type	Digital Input	Digital Input	Digital Input	Digital Input	Screen not avail	Digital Input	Digital Input	Digital Input
EVO Config.	This screen is only present if 'Electronic Expansion Valve Fitted' is set as 'YES' in Config 03 screen - Advanced EEV settings contact manufacturer for more information.								
I/O Config 01	Entering Water Sensor Fitted	Yes	Yes	Yes	Yes	Yes	Yes	Yes	Yes
	Leaving Water Sensor Fitted	Yes	Yes	Yes	Yes	Yes	Yes	Yes	Yes
I/O Config 02	Out. Coil Sensor	Yes Carel NTC	Yes Carel NTC	Yes Carel NTC	Yes Carel NTC	Screen not avail	No	No	No
I/O Config 03	LP sensor fitted	No Ratiometric	No Ratiometric	No Ratiometric	No Ratiometric	Screen not avail	No Ratiometric	No Ratiometric	No Ratiometric
I/O Config 04	HP sensor fitted	No Ratiometric	No Ratiometric	No Ratiometric	No Ratiometric	Screen not avail	No Ratiometric	No Ratiometric	No Ratiometric
I/O Config 05	Out Air Sensor	No 4 ~ 20mA	No 4 ~ 20mA	No 4 ~ 20mA	No 4 ~ 20mA	No 4 ~ 20mA	No 4 ~ 20mA	No 4 ~ 20mA	No 4 ~ 20mA
I/O Config 07	Digital Inputs NO/NC	Set all 10 values as required	Set all 10 values as required	Set all 10 values as required	Set all 10 values as required	Set all 10 values as required	Set all 10 values as required	Set all 10 values as required	Set all 10 values as required
I/O Config 08	Comp min on delay	10s	10s	10s	10s	10s	10s	10s	10s
	Min off delay	120s	120s	120s	120s	120s	120s	120s	120s
	Min on-on delay	360s	360s	360s	360s	360s	360s	360s	360s
I/O Config 09 <sup>(1)</sup>	Min time between start 2 diff comps	20s	20s	20s	20s	20s	20s	20s	20s
I/O Config 10	RV Change over delay	Screen not avail	31s	31s	Screen not avail	Screen not avail	Screen not avail	31s	Screen not avail
	RV Max idle time	Screen not avail	300s	300s	Screen not avail	Screen not avail	Screen not avail	300s	Screen not avail
I/O Config 11	Cond. Set point	35.0	35.0	35.0	35.0	Screen not avail	35.0	35.0	35.0
	Evap set point	5.0	5.0	5.0	5.0	Screen not avail	5.0	5.0	5.0
	differential	3.0	3.0	3.0	3.0	Screen not avail	3.0	3.0	3.0

<sup>(1)</sup> This screen is only present if 'No.Compressors' is set as 2, 3 or 4

### PROGRAMMING USING SMARTKEY (HOTKEY)

1. Turn heat pump OFF.
2. Disconnect any additional stages at R+/R-/GND terminal plugs.
3. Disconnect telephone cable from control panel and plug cable into SmartKey.
4. Turn heat pump ON.
5. The lights on the SmartKey will flash momentarily and beep, then the up and down arrows will flash. Do not push anything.
6. When the start and mode buttons and up arrow illuminate solid, push and release 'Start' to begin programming.
7. The up arrow will flash and the SmartKey will beep when programming is complete.
8. Turn heat pump OFF.
9. Disconnect telephone cable from SmartKey and plug cable back into control panel.
10. Turn heat pump ON and check settings are correct (refer to 'Initial System Setup' on page 19).
11. Make changes to parameter settings as required.

### ENABLE UNIT ON / OFF BY FLOW SWITCH

If the system water pump is controlled by the heat pump, the 'Enable Unit On / Off by Flow Switch' parameter should be set to 'Off'. If the flow switch does not activate, the controller will then provide a 'Water Flow Fault' alarm indication.

If the system pump is NOT controlled by the heat pump, the 'Enable Unit On / Off by Flow Switch' parameter should be set to ON. If the flow switch does not activate, the controller will then provide a 'Unit OFF by FLOW S/W' message indication (not an alarm condition).

1. Whilst in the home screen, press and release **Esc**. The screen will change to the 'Main menu' screen.
2. Press and release **↑** or **↓** until **H. Manufacturer** is selected.
3. Press and release **←** and enter the four digit password (Set first digit then press **←** to move to the next digit etc). When the last digit has been set press and release **←**. Note: This step will not occur if the password has been previously entered within 10 minutes.
4. Press and release **↑** or **↓** until **c. Factory settings** is selected.
5. Press and release **←**. The **Factory settings** 'Enable Unit On / Off' screen will be displayed.
6. Press and release **←** to move cursor to 'By Flow Switch'.
7. Press and release **↑** or **↓** to select 'Yes' or 'No' as appropriate.
8. Press and release **Esc** three times to go back to the home menu.

### VIEWING INPUTS & OUTPUTS ON THE CONTROL PANEL

1. Whilst in the home screen, press and release **Esc**. The screen will change to the 'Main menu' screen.
2. Press and release **↑** or **↓** until **D. Input/Output** is selected.
3. Press and release **←**. The **Input/Output 01** screen will be displayed.
4. Press and release **↓** to view the different Input/Output screens. Proceed to the next step when all viewing is complete.

## ADVANCED SETUP & ADVANCED FUNCTIONS

5. Press and release **Esc** twice to go back to the home menu.

### Input/Output Table

Name On Screen	Corresponding Input/Output Terminal	Other Rqd Terminal/s	Type
Entering Temperature	B1	GND	Carel NTC
Leaving Temperature	B2	GND	Carel NTC
Coil Sensor	B3	GND	Carel NTC
Suction Temperature	B4	GND	Fast Acting Carel NTC
Suction Pressure	B6 (White Lead)	+5VR (Black Lead) GND (Green Lead)	0-5V Ratiometric Pressure Transducer
Discharge Pressure	B7 (White Lead)	+5VR (Black Lead) GND (Green Lead)	0-5V Ratiometric Pressure Transducer
LP Switch	D11	DIC1	N/C Pressure Switch
HP Switch	D12	DIC1	N/C Pressure Switch
Address 1	D13	DIC1	For choosing stages
Address 2	D14	DIC1	For choosing stages
Flow Switch	D15	DIC1	N/O Input
DRED Input	D16	DIC1	N/O Input
Remote ON/Off	D17	DIC1	N/O Input
Compressor	NO1	C1	N/O Relay Contacts
Reversing Valve	NO2	C1	N/O Relay Contacts
Fan: Low	NO3	C1	N/O Relay Contacts
Fan: High	NO4	C2	N/O Relay Contacts
Circulating Pump	NO6	C2	N/O Relay Contacts
Alarm	NO7	C3	N/O Relay Contacts
Alarm	NC7	C3	N/C Relay Contacts
Remote Mode Cool Signal	NO1	C1	N/O Relay Contacts
Remote Mode Heat Signal	NO2	C1	N/O Relay Contacts

## BMS INFORMATION

### SUPERVISOR PARAMETERS TABLE

Address	Mask Index	Display description	Description	Default	UOM	Min	Max	Read/Write	Variable name
1			reading from input 1	0	---	-3277	3277	R	Probe_Value_1
2			reading from input 2	0	---	-3277	3277	R	Probe_Value_2
3			reading from input 3	0	---	-3277	3277	R	Probe_Value_3
4			reading from input 4	0	---	-3277	3277	R	Probe_Value_4
5			reading from input 5	0	---	-3277	3277	R	Probe_Value_5
6			reading from input 6	0	---	-3277	3277	R	Probe_Value_6
7			reading from input 7	0	---	-3277	3277	R	Probe_Value_7
8			reading from input 8	0	---	-3277	3277	R	Probe_Value_8
9			reading from input 9	0	---	-3277	3277	R	Probe_Value_9
10			reading from input 10	0	---	-3277	3277	R	Probe_Value_10
11			reading from input 11	0	---	-3277	3277	R	Probe_Value_11
12			reading from input 12	0	---	-3277	3277	R	Probe_Value_12
13			Analoge Output 1	0	---	0	9999	R/W	AOut_1
14			Analoge Output 2	0	---	0	9999	R/W	AOut_2
15			Analoge Output 3	0	---	0	9999	R/W	AOut_3
16			Analoge Output 4	0	---	0	9999	R/W	AOut_4
17			Current entering water Setpoint	22	Â°C	0	45	R/W	Active_Setpoint
18		Outdoor Fan settings Cond. Setpoint: Åž	Condenser setpoint for outdoor fan control	35	Â°C	10	99.9	R/W	Out_Cond_set
19		Evap. Setpoint: Åž	Evaporator setpoint for outdoor fan control	5	Â°C	-10	99.9	R/W	Out_Evap_set
20			Room Setpoint	22	Â°C	5	45	R/W	Room_Setpoint
21		Prop. band: Åž	Proportional Band for compressor	1.5	Â°C	0	9.9	R/W	Pro_band
22		Dead band: Åž	Dead band	1	Â°C	0	9.9	R/W	D_Band
23			Offset to cooling when economy cycle active	2	Â°C	0	9.9	R/W	Econ_offset
24			Proportional band for economy cycle	1.5	Â°C	0	9.9	R/W	Econ_Pro_band
25			Differential temp between Room and Outside to enable econ cycle	1	Â°C	-2	9	R/W	Econ_diff
26			Min outside damper position when running	20	%	0	99.9	R/W	Econ_min_damper
27			Min outside air temp to enable economy cycle	14	Â°C	0	25	R/W	Econ_min_OAT
28			Maximum supply air temperature	50	Â°C	10	70	R/W	Supply_max
29			Minimum supply air temperature	10	Â°C	-5	35	R/W	Supply_min
30			Condenser setpoint for outdoor fan control	45	Â°C	10	99.9	R/W	Cond_set
31		Prop. Band: Åž	Condenser fan proportional band	5	Â°C	0.1	15	R/W	Cond_Band
32		Outdoor Fan settings Minimum speed: %	Condenser fan minimum speed	20	---	0	100	R/W	Cond_Fan_min
33			Active Proportional Band for compressor	1.5	Â°C	0	9.9	R/W	Active_Pro_band
34		Maximum speed: %	Condenser fan maximum speed	100	---	0	100	R/W	Cond_Fan_max
36			Chilled / Heating water leaving temperature	0	Â°C	-3277	3277	R	CHW_L_Temp
40			Chilled / Heating water Return temperature	0	Â°C	-3277	3277	R	CHW_R_Temp
51			Chilled water tank temperature	0	Â°C	-99.9	99.9	R/W	CHW_Tank_temp
52			CHW tank setpoint	-2	Â°C	-15	99.9	R/W	CHW_Tank_set
56			CHW tank differential to switch off	2	Â°C	0.1	9.9	R/W	CHW_tank_diff



**BMS INTEGER VARIABLES TABLE**

Address	Mask Index	Display description	Description	Default	UOM	Min	Max	Read/Write	Variable name
1			Compressor 3 Hour run counter (high)	0	---	0	999	R	Comp_T_Hours_H_3
2		Compressor 3: 00000 H	Compressor 3 Hour run counter (low)	0	---	0	999	R	Comp_T_Hours_L_3
3		Start pulse: s	Condenser fan start pulse length	0	s	0	9	R/W	Cond_fan_pulse
4		Min between: m	Delay between two consecutive de-ice cycles	20	min	0	999	R/W	De_ice_del_between
5		De-ice timers Delay to start: m	De-Ice initialisation cumulative time	5	min	0	99	R/W	De_ice_init_time
6		Max duration: m	Maximum duration of a de ice cycle	15	min	0	999	R/W	De_ice_max
7		min off delay: s	Compressor minimum off time	0	s	0	999	R/W	Min_Time_OFF_ON
8		Comp min on delay: s	Compressor minimum on to off time delay	0	s	0	999	R/W	Min_Time_ON_OFF
9		min on - on delay: s	Compressor minimum time between start to start	0	s	0	999	R/W	Min_Time_ON_ON_Same
10			Indoor fan Hour run counter (low)	0	---	0	999	R	Indoor_fan_T_Hours_L
11			Indoor fan Hour run counter (high)	0	---	0	999	R	Indoor_fan_T_Hours_H
12			Compressor 1 Hour run counter (low)	0	---	0	999	R	Comp_T_Hours_L_1
13		Compressor 1: 00000 H	Compressor 1 Hour run counter (high)	0	---	0	999	R	Comp_T_Hours_H_1
14		Compressor 2: 00000 H	Compressor 2 Hour run counter (low)	0	---	0	999	R	Comp_T_Hours_L_2
15			Compressor 2 Hour run counter (high)	0	---	0	999	R	Comp_T_Hours_H_2
16		Circ. pump: 00000 H	Pump Hour run counter (high)	0	s	0	999	R	Pump_T_Hours_H
17			Pump Hour run counter (low)	0	---	0	999	R	Pump_T_Hours_L
18		Outdoor Fan1: 00000 H	Outdoor fan 1 Hour run counter (high)	0	---	0	999	R	OutFan_T_Hours_H_1
19			Outdoor Fan 1 Hour run counter (low)	0	---	0	999	R	OutFan_T_Hours_L_1
20			Outdoor fan 2 Hour run counter (high)	0	---	0	999	R	OutFan_T_Hours_H_2
21		Outdoor Fan2: 00000 H	Outdoor Fan 2 Hour run counter (low)	0	---	0	999	R	OutFan_T_Hours_L_2
22			Compressor 4 Hour run counter (high)	0	---	0	999	R	Comp_T_Hours_H_4
23		Compressor 4: 00000 H	Compressor 4 Hour run counter (low)	0	---	0	999	R	Comp_T_Hours_L_4
24			Outdoor fan 3 Hour run counter (high)	0	---	0	999	R	OutFan_T_Hours_H_3
25		Outdoor Fan3: 00000 H	Outdoor Fan 3 Hour run counter (low)	0	---	0	999	R	OutFan_T_Hours_L_3
26			Outdoor fan 4 Hour run counter (high)	0	---	0	999	R	OutFan_T_Hours_H_4
27		Outdoor Fan4: 00000 H	Outdoor Fan 4 Hour run counter (low)	0	---	0	999	R	OutFan_T_Hours_L_4
28			Current actual setpoint	0	---	-32768	32767	R	Set_act
100				15018	---	0	32767	R	BMS_Sw_Ver
101				15018	---	0	32767	R	BMS_Sw_Date
102		Insert manufacturer password(PW2): 000		0	---	0	9999	R	Manuf_Password
103	0	0	Current year	0	---	0	99	R	CURRENT_YEAR
104	00,00/00	0	Current month	1	---	1	12	R	CURRENT_MONTH
		00/00							
105	00,00/00	0	Current day	1	---	1	31	R	CURRENT_DAY

**BMS DIGITAL VARIABLES TABLE**

Address	Mask Index	Display description	Description	Default	UOM	Min	Max	Read/Write	Variable name
1			Digital Input 1	0	---	0	1	R	Din_1
2			Digital Input 2	0	---	0	1	R	Din_2
3			Digital Input 3	0	---	0	1	R	Din_3
4			Digital Input 4	0	---	0	1	R	Din_4
5			Digital Input 5	0	---	0	1	R	Din_5
6			Digital Input 6	0	---	0	1	R	Din_6
7			Digital Input 7	0	---	0	1	R	Din_7
8			Digital Input 8	0	---	0	1	R	Din_8
9			Digital Input 9	0	---	0	1	R	Din_9
10			Digital Input 10	0	---	0	1	R	Din_10
11			Digital Input 11	0	---	0	1	R	Din_11
12			Digital Input 12	0	---	0	1	R	Din_12
13			Digital Input 13	0	---	0	1	R	Din_13
14			Digital Input 14	0	---	0	1	R	Din_14
15			Digital Input 15	0	---	0	1	R	Din_15
16			Digital Input 16	0	---	0	1	R	Din_16
17			Digital Input 17	0	---	0	1	R	Din_17
18			Digital Input 18	0	---	0	1	R	Din_18
19			Digital Output 1	0	---	0	1	R/W	DOut_1
20			Digital Output 2	0	---	0	1	R/W	DOut_2
21			Digital Output 3	0	---	0	1	R/W	DOut_3
37		Comp. enabled:	remote / maintenance enable of compressor 1	1	---	0	1	R/W	Comp1_En
38		Comp. enabled:	remote / maintenance enable of compressor 2	1	---	0	1	R/W	Comp2_En
39			remote / maintenance enable of compressor 3	1	---	0	1	R/W	Comp3_En
40			remote / maintenance enable of compressor 4	1	---	0	1	R/W	Comp4_En
51			Alarm reset from supervisory	1	---	0	1	R/W	RST_Alarms
60		DI 1:	Normally closed normally open change over for Dig in 1	0	---	0	1	R/W	NC_NO_Din_1
61		DI 2:	Normally closed normally open change over for Dig in 2	0	---	0	1	R/W	NC_NO_Din_2
62		DI 3:	Normally closed normally open change over for Dig in 3	0	---	0	1	R/W	NC_NO_Din_3
63		DI 4:	Normally closed normally open change over for Dig in 4	0	---	0	1	R/W	NC_NO_Din_4
64		DI 5:	Normally closed normally open change over for Dig in 5	0	---	0	1	R/W	NC_NO_Din_5
65		DI 6:	Normally closed normally open change over for Dig in 6	0	---	0	1	R/W	NC_NO_Din_6
66		DI 7:	Normally closed normally open change over for Dig in 7	0	---	0	1	R/W	NC_NO_Din_7
67		DI 8:	Normally closed normally open change over for Dig in 8	0	---	0	1	R/W	NC_NO_Din_8
68		DI 9:	Normally closed normally open change over for Dig in 9	0	---	0	1	R/W	NC_NO_Din_9
69		DI 10:	Normally closed normally open change over for Dig in 10	0	---	0	1	R/W	NC_NO_Din_10
70			Normally closed normally open change over for Dig in 11	0	---	0	1	R/W	NC_NO_Din_11
71			Normally closed normally open change over for Dig in 12	0	---	0	1	R/W	NC_NO_Din_12
72			Normally closed normally open change over for Dig in 13	0	---	0	1	R/W	NC_NO_Din_13
73			Normally closed normally open change over for Dig in 14	0	---	0	1	R/W	NC_NO_Din_14
74			Normally closed normally open change over for Dig in 15	0	---	0	1	R/W	NC_NO_Din_15
75			Normally closed normally open change over for Dig in 16	0	---	0	1	R/W	NC_NO_Din_16

Continued on next page.

Continued from previous page.

Address	Mask Index	Display description	Description	Default	UOM	Min	Max	Read/Write	Variable name
76			Normally closed normally open change over for Dig in 17	0	---	0	1	R/W	NC_NO_Din_17
77			Normally closed normally open change over for Dig in 18	0	---	0	1	R/W	NC_NO_Din_18
121			Alarm from probe on input 1	0	---	0	1	R	AI_probe_1
122			Alarm from probe on input 2	0	---	0	1	R	AI_probe_2
123			Alarm from probe on input 3	0	---	0	1	R	AI_probe_3
124			Alarm from probe on input 4	0	---	0	1	R	AI_probe_4
125			Alarm from probe on input 5	0	---	0	1	R	AI_probe_5
126			Alarm from probe on input 6	0	---	0	1	R	AI_probe_6
127			Alarm from probe on input 7	0	---	0	1	R	AI_probe_7
128			Alarm from probe on input 8	0	---	0	1	R	AI_probe_8
129			Alarm from probe on input 9	0	---	0	1	R	AI_probe_9
130			Alarm from probe on input 10	0	---	0	1	R	AI_probe_10
131			Alarm from probe on input 11	0	---	0	1	R	AI_probe_11
132			Alarm from probe on input 12	0	---	0	1	R	AI_probe_12

Contact Accent Air for more information on BMS setup and operation.

### BOARD SWITCH MENU

This menu is intended for service personnel only and is not covered in these instructions. Contact Accent Air for more information.

### SERVICE MENU

This menu is intended for service personnel only and is not covered in these instructions. Contact Accent Air for more information.

## ALARM INDICATION & TROUBLESHOOTING

### CONTROL PANEL ALARM INDICATION

The following indication is displayed when a fault or external control condition is detected.

Alarm	Component	Check
Probe 1 faulty or wiring open/short circuit <sup>(1)</sup>	Water inlet temp sensor	Wiring connections at GND & B1
		Sensor resistance value
Probe 2 faulty or wiring open/short circuit <sup>(1)</sup>	Water outlet temp sensor	Wiring connections at GND & B2
		Sensor resistance value
Probe 3 faulty or wiring open/short circuit <sup>(1)</sup>	Outdoor coil temp sensor	Wiring connections at GND & B3
		Sensor resistance value
Probe 4 faulty or wiring open/short circuit <sup>(1)</sup>	Suction temp sensor	Wiring connections at GND & B4
		Sensor resistance value
Probe 5 faulty or wiring open/short circuit <sup>(1)</sup>	Current sensor. Not used	N/A
Probe 6 faulty or wiring open/short circuit <sup>(1)(2)</sup>	Suction pressure sensor	Wiring connections at GND, +5VR & B6
Probe 7 faulty or wiring open/short circuit <sup>(1)(2)</sup>	Discharge pressure sensor	Wiring connections at GND, +5VR & B7
Low Pressure 1 safety fault	Low pressure switch 1	Is there a low pressure fault?
		Wiring connections at DIC1 & DI1
High Pressure 1 safety fault	High pressure switch 1	Is there a high pressure fault?
		Wiring connections at DIC1 & DI2
Water flow fault <sup>(1)</sup>	Water flow switch	Is there a water flow fault?
		Wiring connections at DIC1 & DI1

<sup>(1)</sup> If relevant component is not installed, ensure relevant I/O config component parameter is set to 'NO'.

<sup>(2)</sup> Ensure sensor parameter is set to 'Ratiometric'.

### OTHER CONTROL PANEL INDICATION

The following indication may also be displayed on the control panel when an external control condition or error condition is detected.

Control Panel Indication	Description	Check
Unit Off by SUPERVISOR	BMS system has turned unit OFF	If no BMS: Go to Menu > Manufacturer > Factory settings > Enable On/Off by Supervisor: No
Unit OFF by Remote in	Remote On/Off on site	If not req: Go to Menu > Manufacturer > Factory settings > Enable On/Off by digital input: No
Unit OFF by FLOW SW	Water pump off	System water pump is turned ON and is operating.
No Link	Control panel address error	Reprogram address by performing step 1 of 'Initial System Setup' on page 19
Disable mask on start up / PGD press enter to change	Control panel button error	Ensure up and down buttons on control panel are not being inadvertently depressed by cover

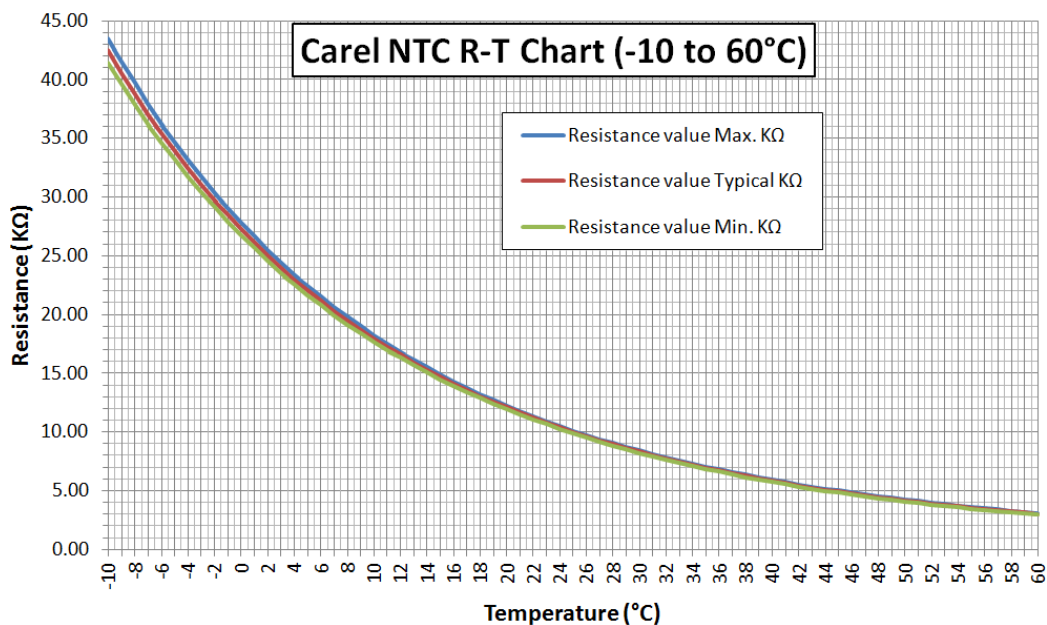

# WIRING DIAGRAM

## WIRING DIAGRAM EXAMPLE – HEAT PUMP / CHILLER UNIT

Note: This wiring diagram is provided here as an example only. Always refer to wiring diagram supplied with heat pump or chiller.

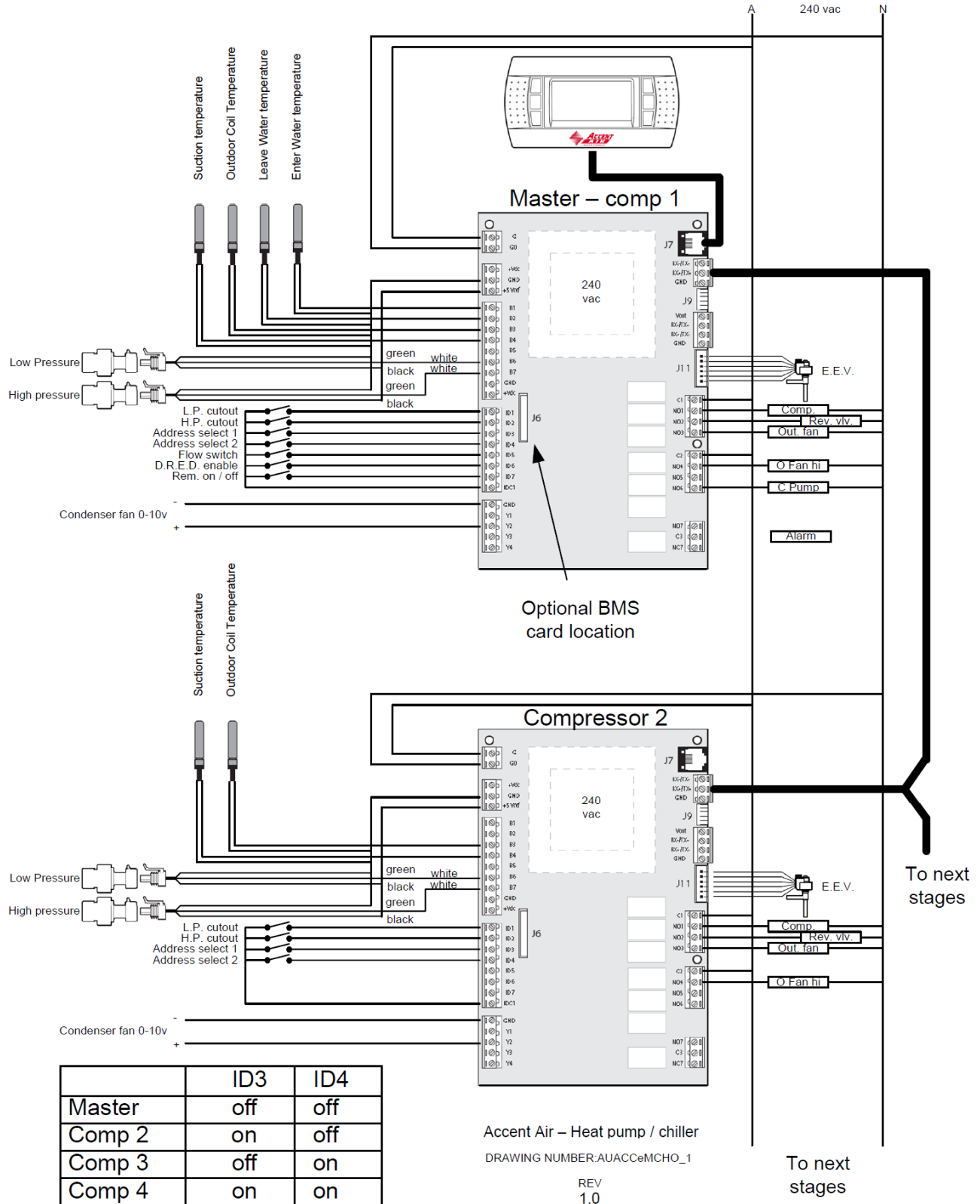

This page is intentionally blank

This page is intentionally blank

This page is intentionally blank